

Article number: 390218502056010

Description: Worm gear
VF 185-FC2-20-180B5, without lubrication

Measures

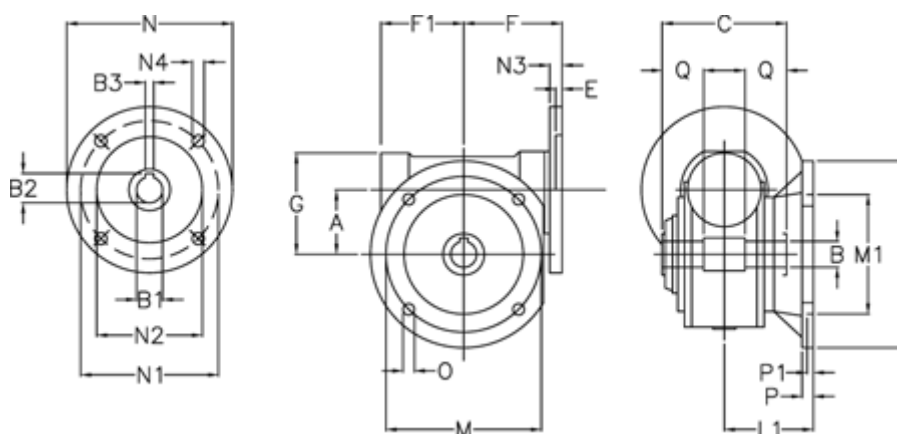

A	= 185.4	F1	= 205	N2	= 250
B	= 60 H7	G	= 267	N3	= 18
B1	E7 = 48	L	= 400	N4	= 18
B2	= 51.2	L1	= 155.5	O	= 22
B3	H9 = 14	M	= 350	P	= 22
C	= 190	M1	= 280	P1	= 13
E	= 4	N	= 350	Q	= 65
F	= 217	N1	= 300		